



APV Paraflow Plate Heat Exchangers

For Chemical Process and Industrial Applications

Combat Corrosion and Ensure Efficiency for Even the Most Challenging Applications

From ultra-pure water to acid cooling to amine, APV combines the widest range of materials (both plate and gasket) and styles with an unmatched level of application experience to deliver optimal performance and maximum protection against process downtime.

Experienced APV engineers will work with you every step of the way from system design to start-up and beyond to ensure you get a solution customized for your specific process.

Advantages for Chemical and Industrial Applications

- Wide selection of gasket and plate materials to stand up to aggressive process fluids
- Ease of cleaning and inspection
- Semi-welded pairs and gasketed plates available
- Semi-welded pairs reduce the chance of leakage
- Flexible configurations can be adapted to meet your changing process needs
- Efficient operation
- High thermal efficiency saves money through reduction in required heat transfer area

- Low liquid hold-up improves start-up time and reduces operating fluid costs
- Achieves up to 97% heat recovery
- Eliminates complicated maintenance such as x-ray, ultrasonic and other non-destructive test procedures
- Corrosion resistant materials reduce inspection and maintenance while ensuring reliable operation
- No moving parts eliminates vibration and reduces maintenance
- Lower capital costs when compared to traditional shell and tube
- Compact design saves space
- Life cycle cost reduction
- Reduced fouling leads to higher thermal efficiency, reducing maintenance and operating costs

Applications

- Bauxite to alumina
- Chlorine alkaline
- Coke oven plant applications
- Soda ash
- Steel plant applications
- Mining applications
- Sulphuric acid
- Titanium dioxide/pigments
- Chloride process
- Zinc Phosphate

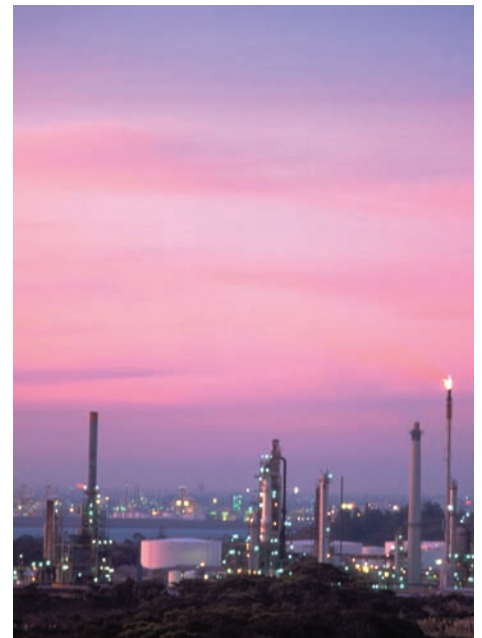

- Acrylic fibers
- Caprolactam (monomer for production of nylon 6)
- Desulphurization
- Ethylene glycol
- Ethylene oxide
- Formaldehyde resins
- Crude oil treatment
- Dehydration/desalting
- Gas compression
- Gas treatment



Efficiency and Reliability Come in All Sizes, Materials, and Configurations

Applications Continued ...

- Gas/oil/water separation
- Oil and gas production
- Polyester
- Polyols
- Polystyrene
- PVC
- Alkylation
- Desulphurization
- MTBE
- Refinery
- Waste water treatment
- Viscose (viscose rayon is regenerated cellulose)
- Distillery pretreatment
- Fermentation
- Alcohol/ethanol
- Pulp and paper
- Beet and cane sugar
- Textiles
- Metal finishing
- Automotive

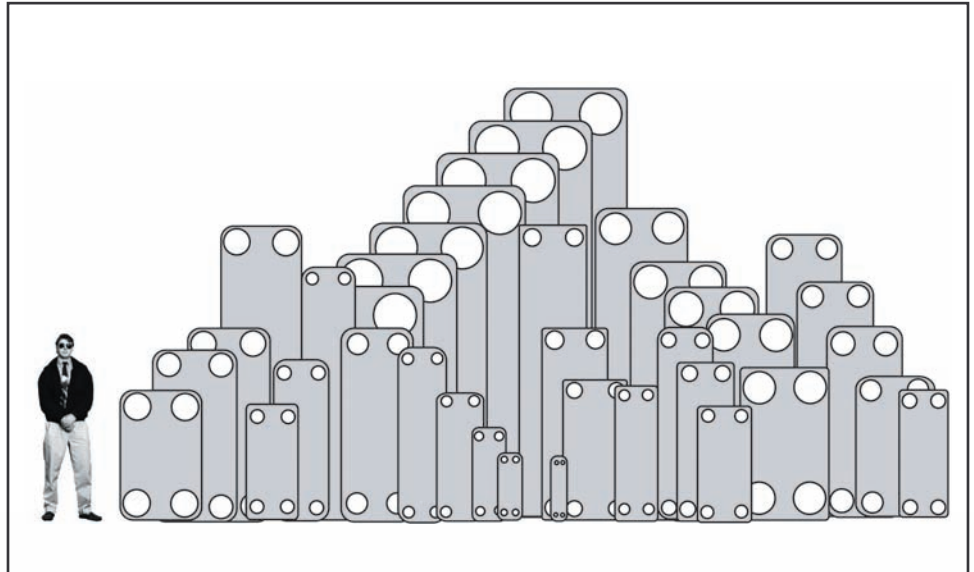

Materials

A wide variety of plate and gasket materials are available depending on your application. Following is a partial list of the more common gasket and plate materials:

Gasket Materials

- Paradur (fluoropolymer)
- Paracent (FDA compliant fluoropolymer)
- EPDM low halide
- Paraflor (high fluorine fluoropolymer)
- CSP (Hypalon)
- Silicone
- Paratemp (resin cured EPDM)
- Peroxide cured EPDM
- Paramine
- Paranile (peroxy cured nitrile)
- Paracil (sulfur cured nitrile)
- Paraprene (Neoprene)
- Parator (hydrogenated nitrile)

Plate Materials

- Austenitic Stainless
- Stainless steel (Gr. 304, 316, 317, 304L, 316L, 317 TI)
 - Alloy AL6XN
 - Alloy 904L
 - Alloy 27-7MO
 - Alloy 254 SMO

Nickel Alloys

- Nickel 200
- Alloy G-30
- Alloy B-2
- Alloy C-22
- Alloy C-276
- Alloy C-2000
- Alloy 33

Other

- Titanium (Gr. 1)
- Titanium palladium (Gr. 7 and 11)

Start Benefiting Today

APV plate heat exchangers reduce maintenance and operating expenses while minimizing down time, delivering the benefits you need to improve the profitability of your process. APV's knowledgeable engineers will work with you every step of the way from system design to implementation and beyond, to ensure you get the optimal performance from your system. To learn more about how APV can help improve your profitability, call our information line at **1-800-207-2708**.

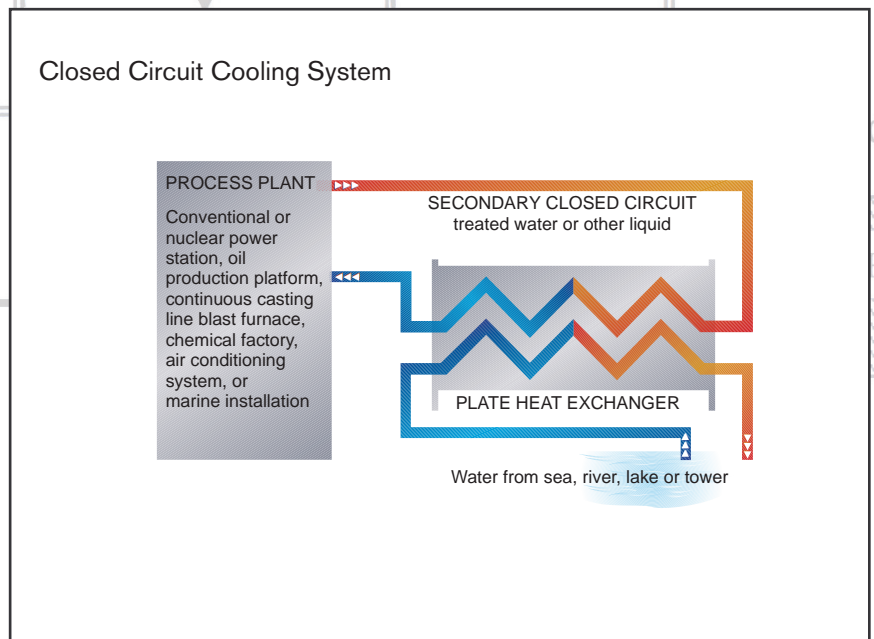
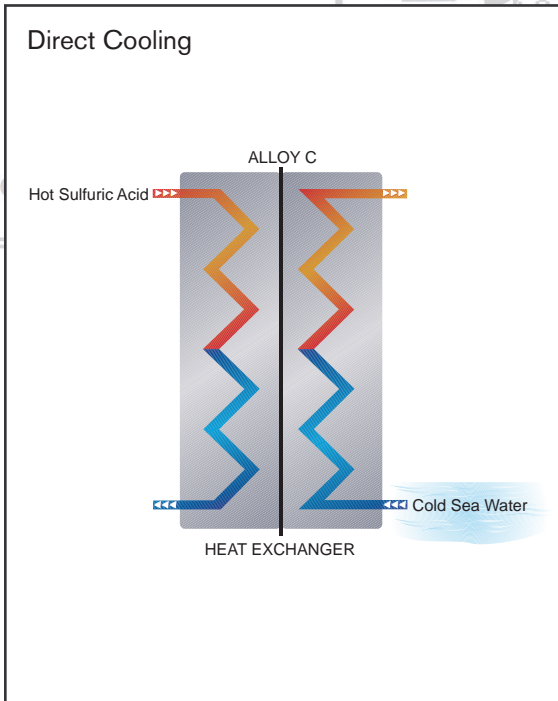
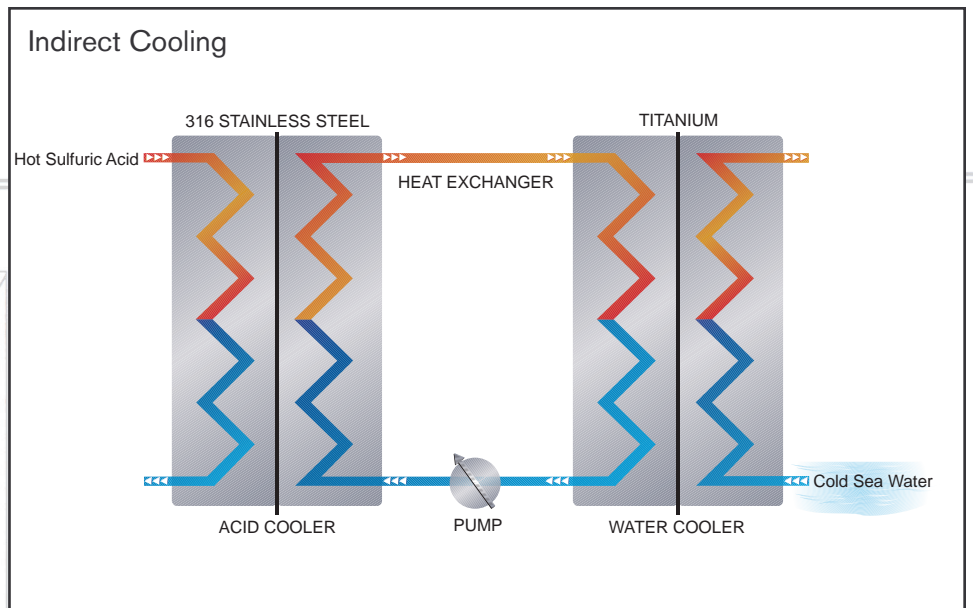

A Wide Range of Plate Heat Exchangers

Chemical Process and Industrial Applications

Model Type	Connection Diameter (Inches)	Maximum US GPM	G	W	D	Standard Frame Length (Inches)**		Maximum Surface Area (ft ²)
						Minimum	Maximum	
APV - SR1	1.5	125	X			17	31	150
APV - SR2	2.0	200	X	X	X	20	59	650
APV - N35	3.0	460	X		X	16	98	1900
APV - Q030	4.0	800	X			40	104	1550
APV - Q055	4.0	800	X			40	104	2850
APV - Q080	4.0	800	X			40	104	4200
APV - SR6GH	4.0	800	X		X	40	104	1450
APV - SR6GL	4.0	800	X		X	40	104	2400
APV - SR6AG	4.0	800	X			40	104	4000
APV - SR6AA	4.0	800	X			40	104	4450
APV - LR4	4.0	800		X		24	66	1250
APV - R5*	4.0	800	X			37	220	3950
APV - ER5*	4.0	800	X			37	220	4000
APV - A055	6.0	1800	X			30	98	2700
APV - A085	6.0	1800	X			30	98	4150
APV - A145	6.0	1800	X			30	98	6900
APV - SR9*	8.0	3100	X			46	136	3200
APV - J060	8.0	3100	X			39	136	3950
APV - J092	8.0	3100	X			39	136	6250
APV - J185	8.0	3100	X			39	136	13800
APV - TR9GN	8.0	3100	X	X		46	110	5050
APV - TR9AV	8.0	3100	X	X		46	110	6700
APV - TR9AL	8.0	3100	X	X		46	110	8700
APV - B063	12.0	7000	X	X		46	197	6100
APV - B110	12.0	7000	X	X		46	197	10650
APV - B134	12.0	7000	X	X		46	197	12850
APV - B158	12.0	7000	X	X		46	197	15050
APV - B205	12.0	7000	X	X		46	197	15850
APV - Z155	16.0	11,000	X			147	265	12050
APV - Z195	16.0	11,000	X			147	265	15150
APV - Z230	16.0	11,000	X			147	265	18250
APV - Z270	16.0	11,000	X			147	265	21250
APV - Z310	16.0	11,000	X			147	265	24200
APV - Z350	16.0	11,000	X			147	246	24550
APV - Z390	16.0	11,000	X			147	246	27300
APV - Z430	16.0	11,000	X			137	236	29750
APV - S190	20.0	20,000	X			156	250	17000
APV - S280	20.0	20,000	X			156	250	25050
APV - S330	20.0	20,000	X			156	250	29400
APV - S380	20.0	20,000	X			156	250	33900

- * Wide Gap
- ** 150# ASME Frame Design as Basis
- G - Gasketed
- W - Welded Plate Pair
- D - Duo-Safety

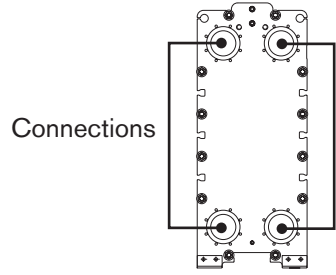
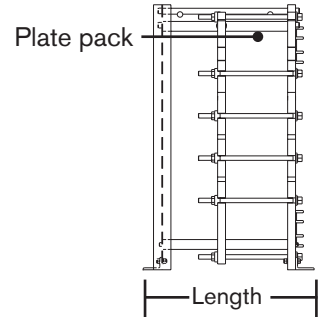

Your local contact:

APV
 105 CrossPoint Parkway
 Getzville, NY 14068
 Phone: (800)207-2708 Fax: (716)692-1715
 E-mail: answers.us@apv.com



For more information about our worldwide locations, approvals, certifications, and local representatives, please visit www.apv.com.

Copyright © 2008 SPX Corporation
 1016-02-06-2008-US

The information contained in this document, including any specifications and other product details, are subject to change without notice. While we have taken care to ensure the information is accurate at the time of going to press, we assume no responsibility for errors or omissions nor for any damages resulting from the use of the information contained herein.